

OK Pipe Systems OK/OKR/OKD

The OK pipe system is ideal
for pneumatic conveying

OK/OKR/OKD Pipes

The OK pipe system is ideal for pneumatic and mechanical conveying and for ventilating applications in both farming and industry.

The simple and flexible pipe systems may be adjusted to suit any specific purpose, resulting in shorter conveying distances and therefore the most efficient and economical solutions.

Applications range from the conveying of crops, waste, paper, plastic granulates and finished components to complete ventilation systems.

Customized systems can be supplied - tailored to meet any specific requirement - whether for conveying or for ventilating.

Robust construction

Tight joints

The sturdily constructed OK pipe system is made from galvanized sheet steel. The rolled pipe ends serve as reinforcements, maintaining the circular shape and ensuring tight joints.

Three pipe diameters

The OK pipe system is available in three different diameters: OK100 (100 mm), OK160 (160 mm) and OK200 (200 mm). The dimensions refer to the outside pipe diameters.

Selection of wall thicknesses

Choice of wall thickness depends largely on the wear to which the pipe system will be exposed. The wide range of pipes is therefore available in different thicknesses - OK standard, OKR reinforced and OKD extra reinforced (for gravity flow).



Full utilization of the air stream

The advanced production machinery ensures a continuous smooth inner surface of the pipeline, thus giving gentle and efficient conveying - even in downpipes - as well as maximum utilization of the air stream.

Modular pipe system

Designed in modular form the OK pipe system comprises pipes, bends, branches, diverters, cyclones, outlets, etc.

The components are assembled quickly and easily using the unique OK quick-release couplings. The wide choice of OK pipes and accessories ensures flexibility and ease of installation in existing buildings.

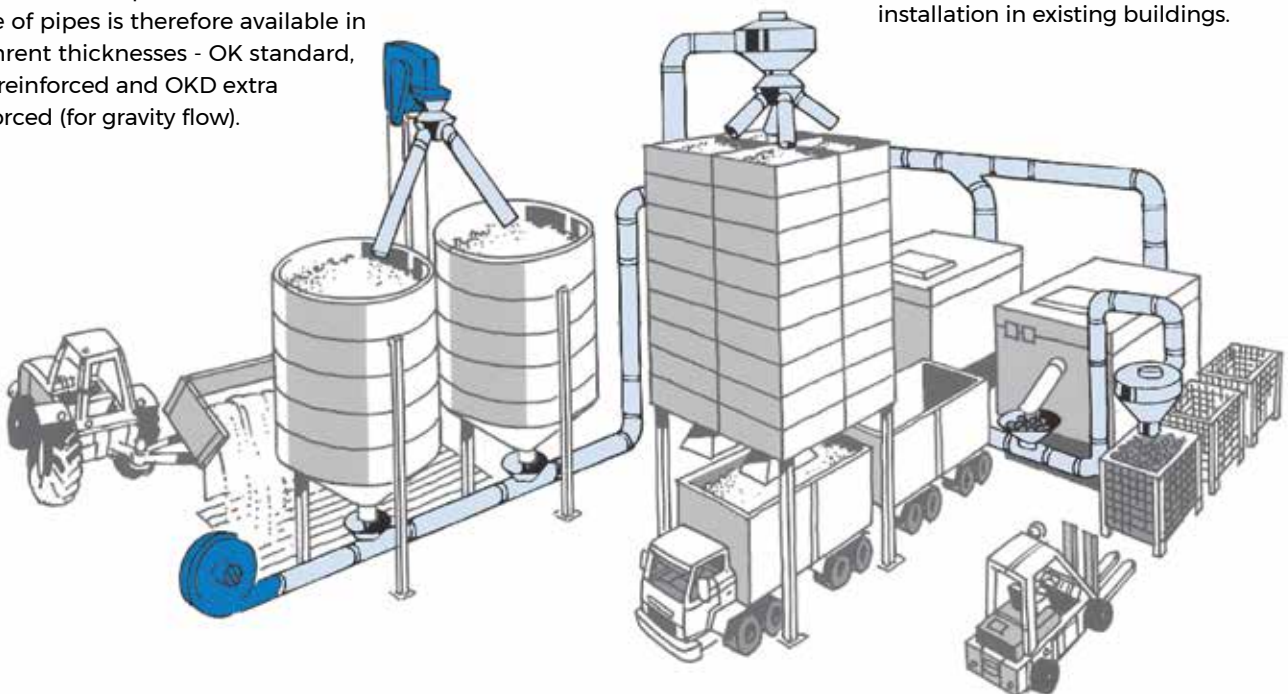



Temporary and permanent installations

Two types of OK couplings are available for temporary and permanent systems, respectively. If the pipe system is to be dismantled or altered frequently, it is advantageous to select the OK quick-release couplings for assembly and removal without the use of tools. The relatively low weight of the OK pipes facilitates assembly.

For permanent systems OK bolt couplings are preferable.

Saving floor space by wall or ceiling mounting

OK pipe supports permit wall and ceiling mounting, thus keeping clear valuable floor space in production premises or storage plants.

Economical in operation

The OK couplings make maintenance and alterations easy tasks. Worn-out parts are replaced and new components added when required. The OK pipe system is so complete that the requirement for special parts will be unlikely.

Modern technology and competitive prices

The modern manufacturing technology together with the carefully devised modular design and the extensive use of standardized components ensures an efficient system at competitive prices. Inquiries for quotations, without obligation, are always welcome.

Easy ordering and prompt delivery

The following pages give detailed technical information and order numbers of the individual items. To expedite delivery always quote these numbers, as all components are stock items.

Pneumatic conveying

OK - OKR

Exhaustion/Ventilation

OK

Downpipe system

OKD

Expertise and know-how

The company has supplied pneumatic pipe systems for many decades. Such experience, of course, adds greatly to knowledge and expertise in this field.

Do not hesitate to consult us for an economical solution that will not only meet the demands of today but will also be easy to alter to those of tomorrow.

Being one of the leading pipe system suppliers in Europe is both an obligation and a privilege.

OK100

Pneumatic Conveying Exhaustion Ventilation

Outer diameter: 100 mm.

Clamps



Quick release clamp, Deltatone.
122 040 165



Clamp with bolt, Deltatone.
122 040 190

Pipes

Thickness of sheet: 0,75 mm.



0,06 m pipe, galv.
122 040 226

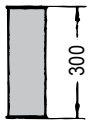

0,3 m pipe, galv.
122 040 119

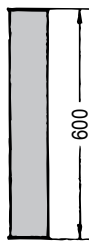

0,6 m pipe, galv.
122 040 118

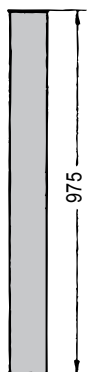

1 m pipe, galv.
122 040 117



2 m pipe, galv.
122 040 116

Telescopic pipe

Thickness of sheet: 0,75 mm

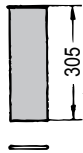

0,3 m telescopic pipe, galv.
122 040 172

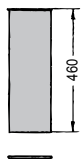

0,5 m telescopic pipe, galv.
122 040 220



Rubber ring
122 040 018

Bends

Thickness of sheet: ins./outs.:
1,0/1,0 mm.

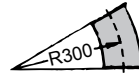

30° bend, paint.
122 040 124

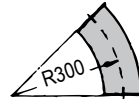

45° bend, paint.
122 040 122

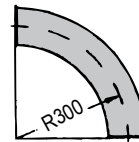

90° bend, paint.
122 040 120

Diverter

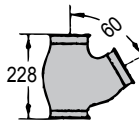

60° 2-way diverter, paint.
122 040 132

Branch pipe

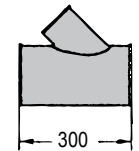

45° branch pipe, paint.
OK160/100/160
131 025 052

Pipe support



Pipe support, galv.
122 040 174

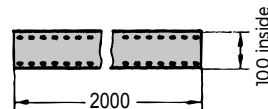

Pipe support extension, galv.
Length 2 m - may be
shortened as needed.
131 025 094

Shutter



Shutter, paint. Shutter seal
131 025 048 131 025 050

Transition



Transition OK100/160, paint.
122 000 308

Adaptor



OK100 adaptor, galv.
122 040 131

Silencer

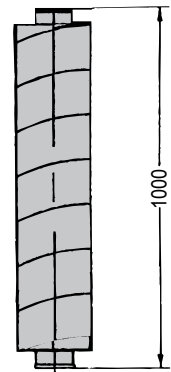

Silencer, galv., w/o baffle
125 500 551

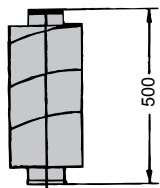

Silencer, galv., w/o baffle
125 500 525

OK160

Pneumatic Conveying Exhaustion Ventilation

Outer diameter: 160 mm.

Clamps



Quick release clamp, Deltatone
122 000 800



Clamp with bolt, Deltatone
122 000 193



Bolt/quick release clamp,
Deltatone.
122 000 648

Pipes

Thickness of sheet: 0.9 mm.



0.06 m pipe, paint.
122 010 011

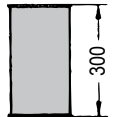

0.3 m pipe, galv.
122 010 010

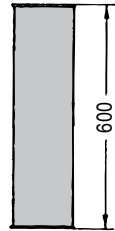

0.6 m pipe, galv.
122 010 008

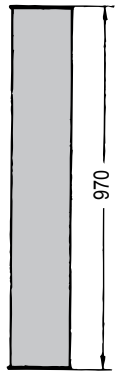

1 m pipe, galv.
122 010 007

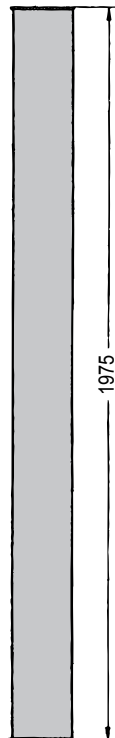

2 m pipe, galv.
122 010 006

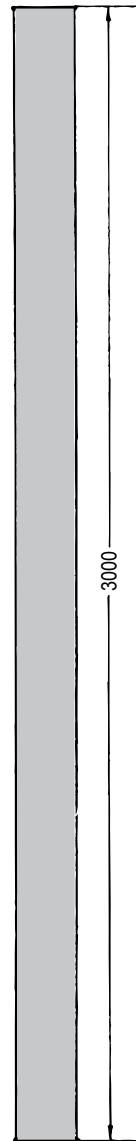

3 m pipe, galv.
122 010 076

Telescopic pipes

Thickness of sheet: 0.9 mm.

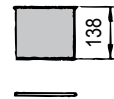

0.1 m telescopic pipe, galv.
122 000 681

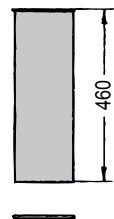

0.5 m telescopic pipe, galv.
122 000 680



O-ring.
122 000 132

Bends

Thickness of sheet: ins./outs.:
1.0/1.5 mm.

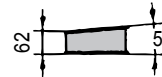

5° bend, paint.
122 020 140

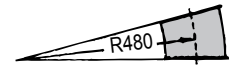

15° bend, paint.
122 020 118

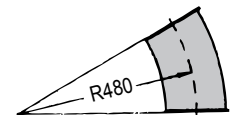

30° bend, paint.
122 020 113

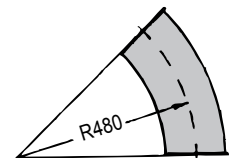

45° bend, paint.
122 020 108

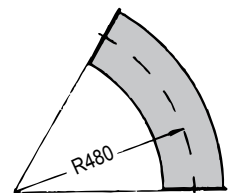

60° bend, paint.
122 020 103

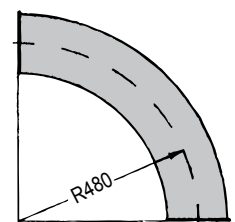

90° bend, paint.
122 020 096

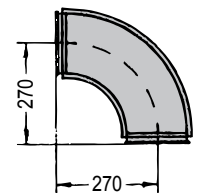

90° bend, paint.
R = 240 (for ventilation only).
Thickness of sheet: 1 mm
122 020 094

Diverters

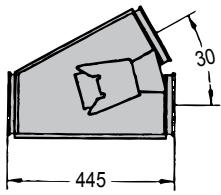

30° 2-way diverter, paint.
122 000 690

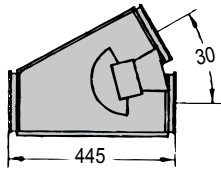

30° 2-way diverter, paint.
Pneumatic operated, w/o
cylinder.
122 000 697



Pneumatic cylinder for 30°
2-way diverter.
122 001 264

30° 2-way diverter, paint,
w/cylinder.
122 001 265

Branch pipes

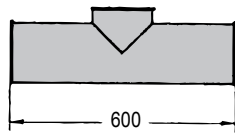

90° branch pipe, paint.
OK160/100/160.
122 000 461

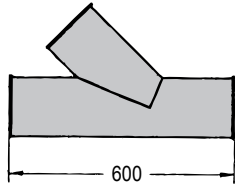

45° branch pipe, paint.
OK160/100/160.
122 000 323

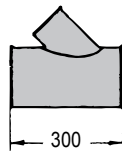

45° branch pipe, paint.
OK160/100/160.
131 025 052

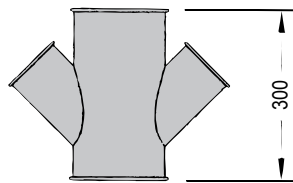

45° OK160 Branch pipe w/2 x
OK100 branches, paint.
122 000 805

Pipe supports

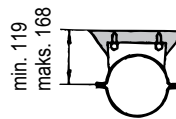

Pipe support, paint.
122 000 702

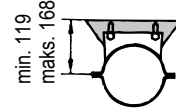

Pipe support, galv.
122 000 360

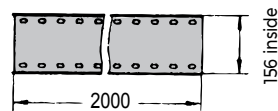

Pipe support extension, galv.
Length 2 m - may be
shortened as needed.
131 025 055

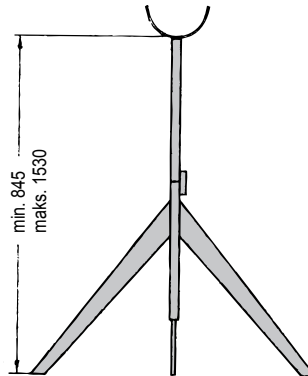

Pipe support, paint.
122 000 705

Shutter



Shutter, paint
(for air regulator).
122 000 853

Transitions



Transition OK100/160, paint.
122 000 308

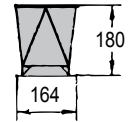

OK160 adaptor with square
flange, paint.
122 000 003

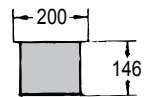

OK160 adaptor with square
flange, paint.
122 000 873

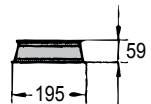

OK160 adaptor with flange,
paint. 121 000 549

Welding adaptors

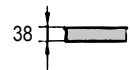

OK160 welding adaptor,
unpainted. 1 mm sheet.
122 000 592



OK160 welding adaptor,
unpainted. 2 mm sheet.
122 020 054

OK160

Cyclones

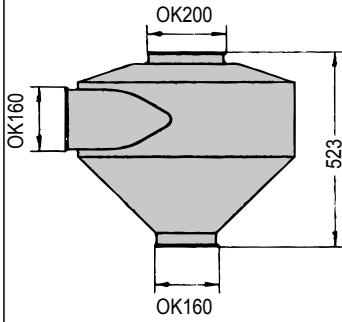

UC cyclone, galv.
(exhaust cyclone).
122 000 698

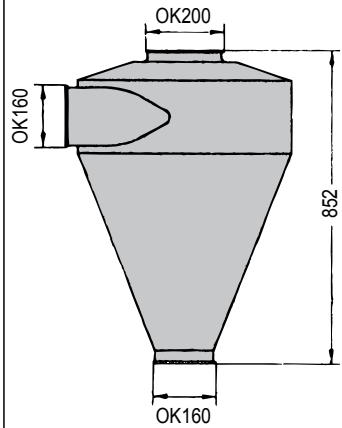

RC cyclone, galv.
(dust cyclone).
131 000 047

Steel flex. hose

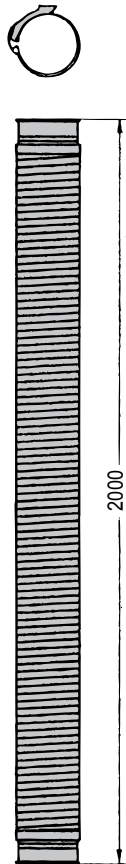

Steel flex. hose (with quick
release clamp).
121 000 639

Flexible polyurethane hoses

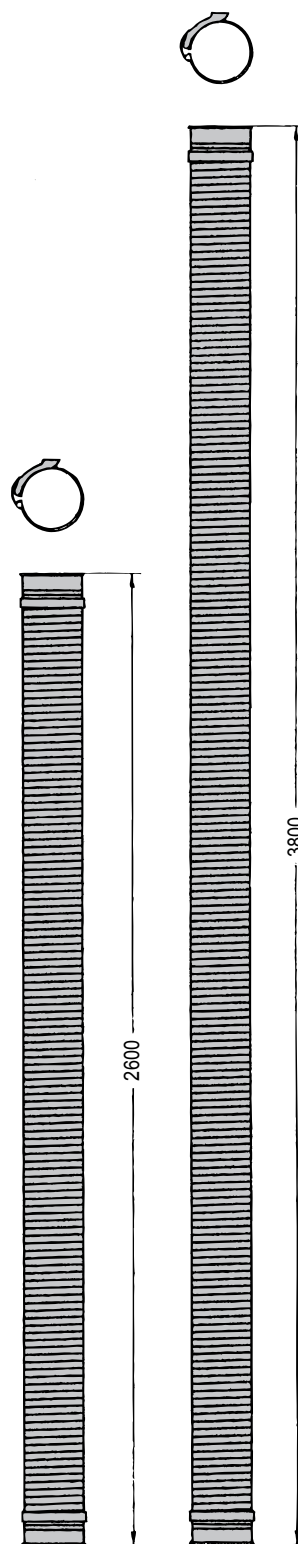

Flexible polyurethane hose
(with quick release clamp).
121 000 645

Flexible polyurethane hose
(with quick release clamp).
121 000 650

Silencer

The conveyed material may
not pass through the silencer.

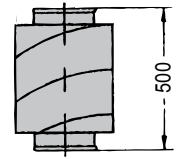

Silencer, galv., w/o baffle
125 500 544

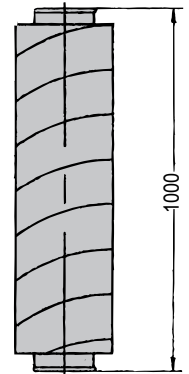

Silencer, galv., w/o baffle
125 500 552

OKR160

Pneumatic Conveying Reinforced Pipe System

Outer diameter: 160 mm.

Clamps



Quick release clamp, Deltatone
122 000 800



Clamp with bolt, Deltatone
122 000 193



Bolt/quick release clamp, Deltatone.
122 000 648

Pipes

Thickness of sheet: 1.25 mm.

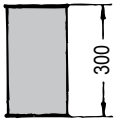

0.3 m pipe, galv.
122 010 043

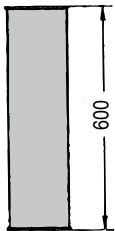

0.6 m pipe, galv.
122 010 042

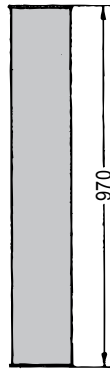

1 m pipe, galv.
122 010 041

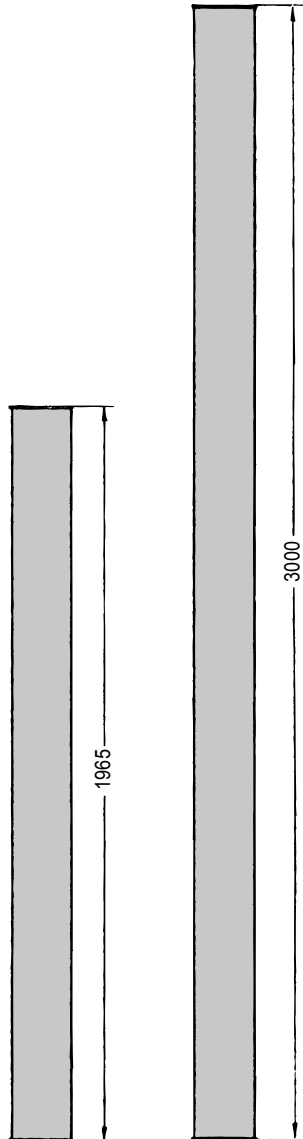

2 m pipe, galv. 3 m pipe, galv.
122 010 040 122 010 079

Telescopic pipe

Thickness of sheet: 1.25 mm

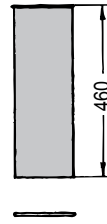

0.5 m telescopic pipe, galv.
122 000 694



O-ring.
122 000 132

Bends

Thickness of sheet: ins./outs.:
1.0/2.5 mm.



15° bend, galv.
122 020 137

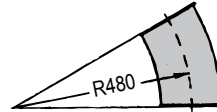

30° bend, galv.
122 020 134

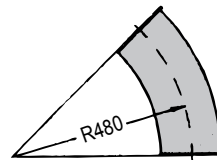

45° bend, galv.
122 020 131

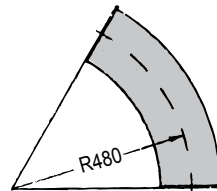

60° bend, galv.
122 020 128

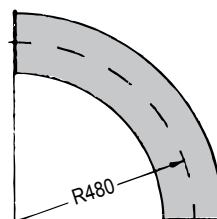

90° bend, galv.
122 020 124

Pipe supports

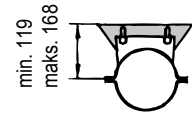

Pipe support, paint.
122 000 702

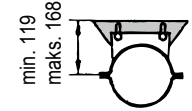

Pipe support, galv.
122 000 360

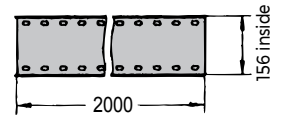

Pipe support extension, galv.
Length 2 m - may be shortened
as needed.
131 025 055

Cyclones

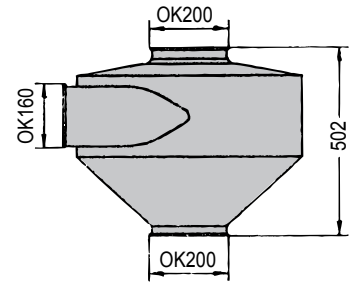

UC cyclone, paint. (exhaust
cyclone with OK160 quick
release clamp).
122 000 872

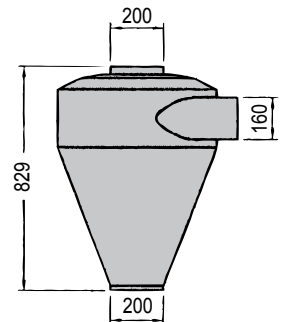

IC cyclone 20°, paint.
(w/interchangeable filter).
131 025 101

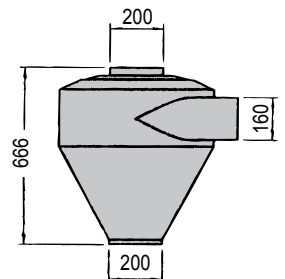

IC Cyclone 30°, paint
(w/interchangeable filter).
121 000 719

Downpipe System

Outer diameter: 160 mm.

Clamps



Quick release clamp, Deltatone
122 000 800



Clamp with bolt, Deltatone
122 000 193



Bolt/quick release clamp, Deltatone.
122 000 648

Pipe

Thickness of sheet: 2 mm.

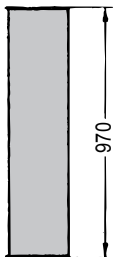

1 m pipe, galv.
122 010 044

Bends

Thickness of sheet: 1.5 mm.

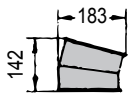

15° bend, paint.
122 022 012

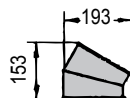

30° bend, paint.
122 022 013

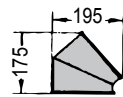

45° bend, paint.
122 022 008

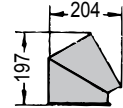

60° bend, paint.
122 022 014

Diverters

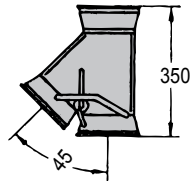

45° 2-way diverter, paint.
122 000 692

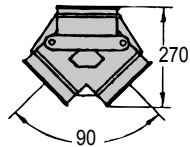

90° 2-way diverter, paint.
124 000 014

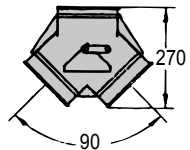

90° 2-way diverter, paint.
Pneumatic operated, incl. cylinder.
124 000 084

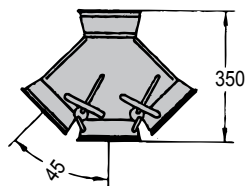

45° 3-way diverter, paint.
122 000 693

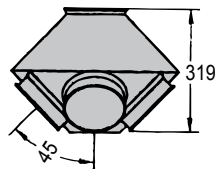

45° 4-way diverter, paint.
122 000 683

Overflow

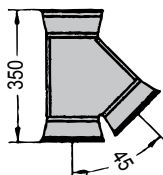

Overflow, paint.
122 000 496

Pipe supports

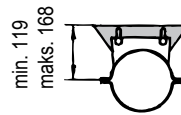

Pipe support, paint.
122 000 702

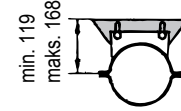

Pipe support, galv.
122 000 360

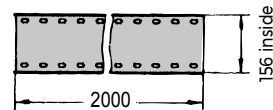

Pipe support extension, galv.
Length 2 m - may be shortened as needed.
131 025 055

Shutter



Shutter, paint.
122 000 685

Shutter seal
131 025 028



Shutter, paint.
Pneumatic operated,
122 000 686

Shutter seal
131 025 028

Shutter



Shutter, paint (for discharge, may be operated from a distance).
124 050 008

Transition



Transition OKD160/200, paint.
121 000 367

Swivel spout

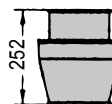

Swivel spout, paint.
124 000 083

Steel flex. hose

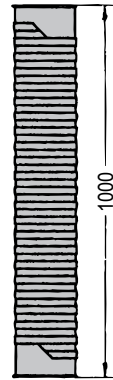

1 m flex. steel hose.
122 000 197

Hoppers

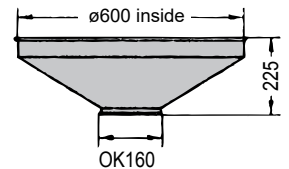

Hopper (w/o intake guard), paint.
122 000 855

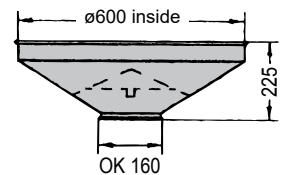

Hopper (with intake guard), paint.
121 100 135

Extension hopper

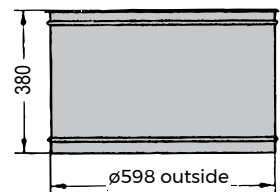

Extension hopper, paint.
122 000 875

Rubber adaptor

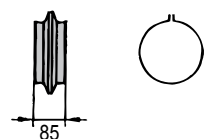

Rubber adaptor (with 2 clamps).
122 000 026

Pneumatic Conveying Exhaustion Ventilation

Outer diameter: 200 mm.

Clamps



Quick release clamp, Deltatone. 122 050 150



Clamp with bolt, Deltatone. 122 050 110

Pipes

Thickness of sheet: 0.9 mm.

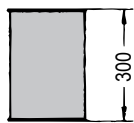

0.3 m pipe, galv. 122 050 086

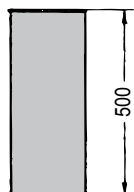

0.5 m pipe, galv. 122 050 085

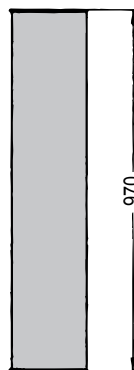

1 m pipe, galv. 122 050 084

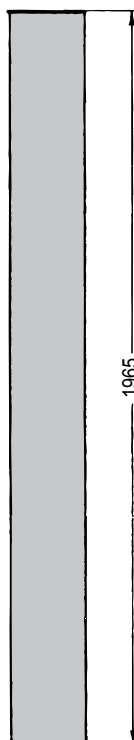

2 m pipe, galv. 122 050 083

Telescopic pipe

Thickness of sheet: 0.9 mm.

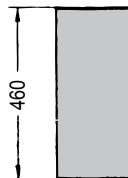

0.5 m telescopic pipe, galv. 122 050 106



O-ring. 122 000 850

Bends

Thickness of sheet: 0.9 mm.

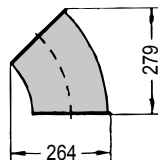

45° bend, galv. R = 300 122 050 115

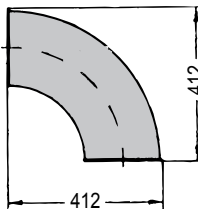

90° bend, galv. R = 300 122 050 116

Pipe support

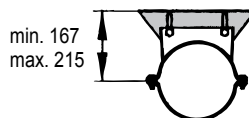

Pipe support, galv. 122 050 134

Shutter

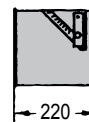

Shutter, paint. (for air regulator). 122 050 117

Cyclone

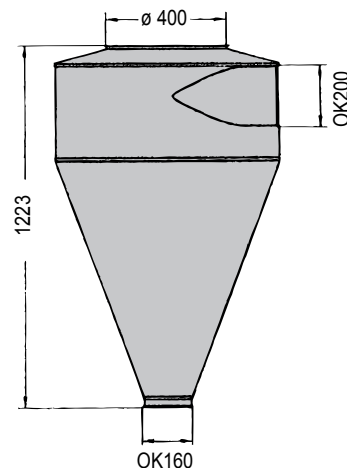

RC cyclone, paint. (dust cyclone). 131 021 007

Steel Flex hose

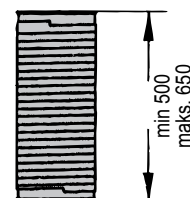

0.5 m flex steel hose. 122 050 156

OKD200

Downpipe System

Outer diameter: 200 mm.

Clamps



Quick release clamp, Deltatone.
122 050 150



Clamp with bolt, Deltatone.
122 050 110

Pipes

Thickness of sheet: 2 mm.



0.15 m pipe, paint.
122 000 455

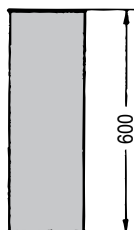

0.6 m pipe, paint.
122 050 043

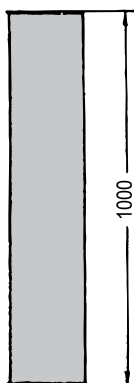

1 m pipe, paint.
122 050 044

1 m pipe, galv.
122 050 217

Telescopic pipe

Thickness of sheet: 2 mm.

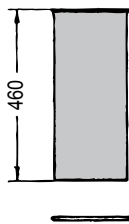

0,5 m telescopic pipe, paint.
122 050 132



O-ring.
122 000 850

Bends

Thickness of sheet: 2 mm.

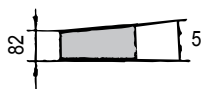

5° bend, paint.
122 050 016



15° bend, paint.
122 050 019

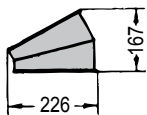

30° bend, paint.
1.5 mm sheet.
122 050 087

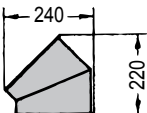

45° bend, paint.
122 050 017

Diverters

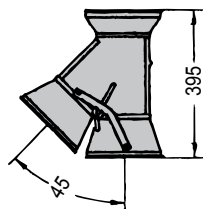

45° 2-way diverter, paint.
122 050 130

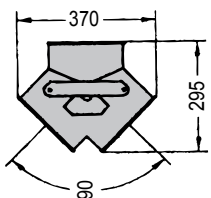

90° 2-way diverter, paint.
122 050 006

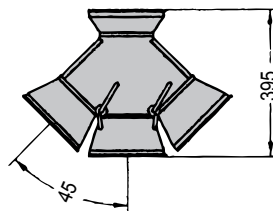

45° 3-way diverter, paint.
122 050 131

Overflow

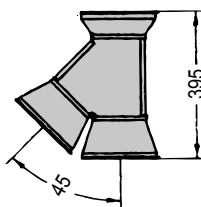

Overflow, paint.
122 050 035

Shutter



Shutter, paint.
121 106 096

Shutter



Shutter, paint. (for discharge, may be operated from a distance).
124 052 045

Transitions

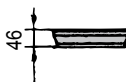

Transition $\varnothing 180/OKD200$, paint.
121 000 629



Transition OKD200/250, paint.
122 050 075

Swivel spout

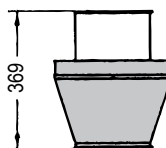

Swivel spout, paint.
122 050 133

Hoppers

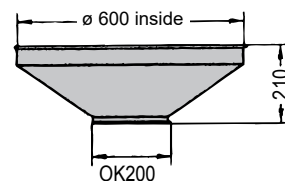

Hopper (w/o intake guard), paint.
121 106 113

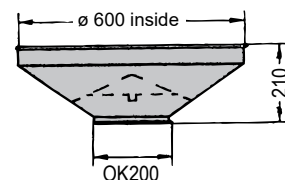

Hopper (with intake guard), paint. 121 106 131

Extension hopper

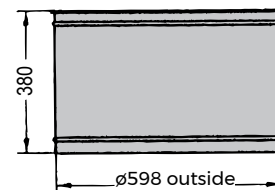

Extension hopper, paint.
122 000 875

Pipe support

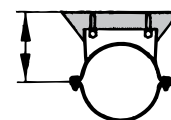

Pipe support, galv.
122 050 134



LET THE AIR DO THE WORK

With over 70 years experience from multiple distributing locations worldwide, Kongskilde Industries specializes in manufacturing dependable, pneumatic conveying and material handling solutions.

A strategic focus in benefiting organizations in paper, plastic, packaging, grain, and additional specialties in industrial markets, Kongskilde's accomplished reputation represents high-quality synonymous with high-value.

Quality Installations from a team of skilled professionals, Kongskilde continuously advances equipment innovations to tailor best-in-class equipment and technical services to enhance process efficiency in the workplace.



Kongskilde Industries A/S

Tel.: +45 72 17 60 50

industry@kongskilde-industries.com

kongskilde-industries.com